

8

AVVITARE

TO SCREW
 APRETAR
 FESTSCHRAUBEN
 VISSER
 VASTSCHROEVEN
 MEGHÚZNI
 WKRECIC
 PRIVITI

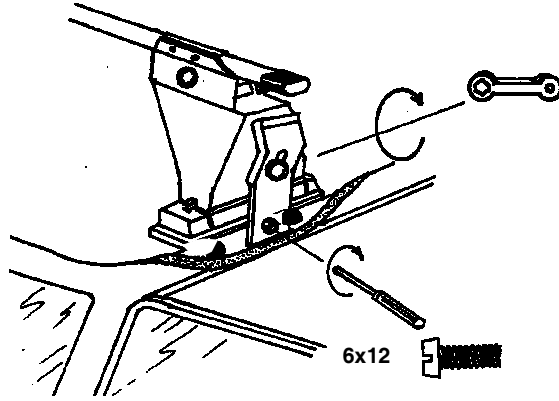

9

OPTIONAL

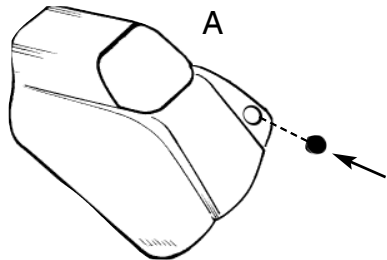

INSERIRE

INSERT
 CUBRIR
 STOPFEN
 ENFILER
 BEVESTIG
 TOLJA FEL
 NALOZIC
 VSTAVITI

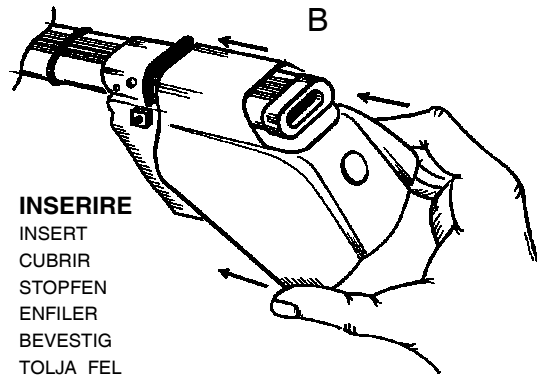

10

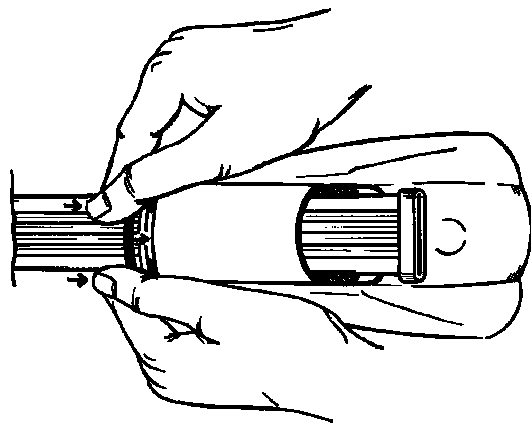

38co

ISTRUZIONI DI MONTAGGIO - FITTING INSTRUCTIONS - INSTRUCCIONES PARA SU MONTAJE -
 MONTAGEANWEISUNGEN - INSTRUCTIONS DE MONTAGE - MONTAGE INSTRUCTIES -
 SZERELÉSI UTASÍTÁS - INSTRUKCJA MONTAZU - NAVODILA O MONTAŽI

“LOGICO”

1



MISURE PRECISE

EXACT DIMENSIONS
 MEDIDAS CORRECTAS
 GENAUUE MASSE
 MESURES EXACTES
 EXACTE AFMETINGEN
 PONTOS MÉRET
 DOKLADNE WYMIARY
 TO»NE MERE

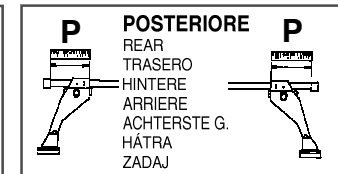
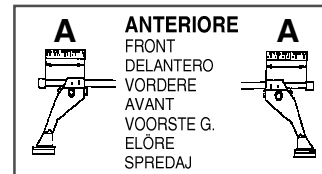
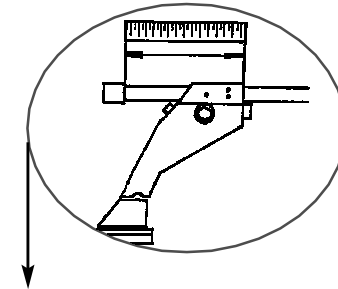

A
ANTERIORE
 FRONT
 DELANTERO
 VORDERE
 AVANT
 VOORSTE G.
 ELSŐ RÚD
 PRZOD
 SPREDAJ

P
POSTERIORE
 REAR
 TRASERO
 HINTERE
 ARRIERE
 ACHTERSTE G.
 HÁTSÓ RÚD
 TYL
 ZADAJ

PEUGEOT 206 3p.

110 mm.

142 mm.

2

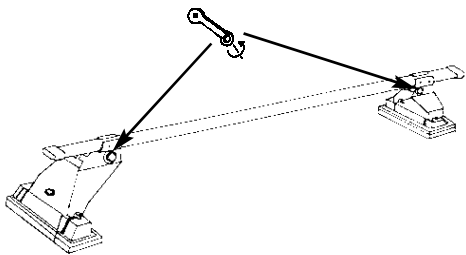
**AVVITARE (A FONDO)**

TO SCREW (DOWN)
 APRETAR (A FONDO)
 FESTSCHRAUBEN
 VISSER (À FOND)
 VASTSCHROEVEN
 MEGHÚZNI
 WKRECIC DO KONCA
 PRIVITI (DO KONCA)

3

TAGLIARE

TO CUT
 CORTAR
 SCHNEIDEN
 COUPER
 SNIJDEN
 ELVÁGNI
 OBCIAC
 ODREZATI

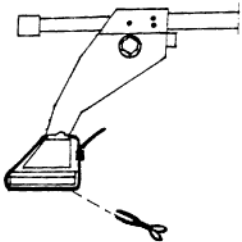

4

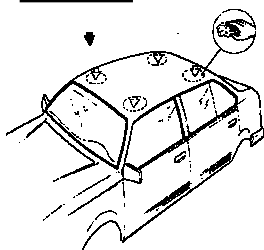
**PULIRE IL TETTO**

CLEAN THE ROOF
 LIMPIAR EL TECHO
 DACH REINIGEN
 NETTOYER LE TOIT
 DAK SCHOONMAKEN
 TISZTÍTSÁ MEG A TETŐT
 WYCZYSZCIC DACH
 O»STITI STREHO

5

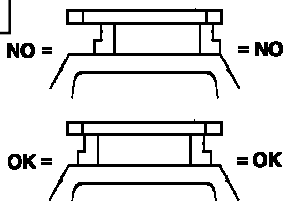
**CENTRARE IL P. TUTTO SUL TETTO**

CENTRE THE UNIVERSAL BAR
 CARRIER ON THE ROOF

CENTRAR EL PORTAEQUIPAJES
 SOBRE EL TECHO

LASTENTRÄGER AUF DEM DACH
 ZENTRIEREN

CENTRER LE TOIT AVEC LE
 PORTE-TOUT

PLAATS DE UNIVERSELE DRAGER
 IN HET MIDDEN VAN HET DAK

HELYEZZE KÖZÉPRE A RUDAKAT

WYSRODKOWAC BAGAŻNIK NA DACHU

CENTRIRATI PRTLJA/ENIK NA STREHO

6

MODELLI AUTO

CARS
 COCHES
 WAGEN
 VOITURES
 AUTO
 AUTÓ TIPUS
 MODELI AVTOMOBILOV

MONTAGGIO GANASCINE

HOW TO ASSEMBLE THE CLAMPS
 COMO MONTAR LAS FIJACIONES
 ZUSAMMENBAU DER
 SPANNBACKEN
 MONTAGE CROCHET
 MONTAGE VAN DE KLEMMEN
 RÖGZITŐ FÜLEK
 MONTAZ SZCZEK MOCUJACYCH
 MONTA/EA NAPENJALNIKA

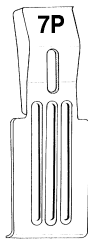

PEUGEOT 206 3p.

ANTERIORE

FRONT
 DELANTERO
 VORDERE
 AVANT
 VOORSTE G.
 ELSŐ RÚD
 PRZOD
 SPREDAJ

N°

2

POSTERIORE

REAR
 TRASERO
 HINTERE
 ARRIERE
 ACHTERSTE G.
 HÁTSÓ RÚD
 TYL
 ZADAJ

N°

7P

7

MODELLI CON PREDISPOSIZIONE DELLA CASA AUTO:

CARS WITH PRE-EXISTING FIXING POINT FROM MANUFACTURER
 MODELOS CON PREDISPOSICION DEL FABRICANTE
 AUTOS MIT VOM HERSTELLER VORGESEHENE BEFESTIGUNGSPUNKTE
 VOITURES AVEC POINTS DE FIXAGE PREVUS PAR LE CONSTRUCTEUR
 AUTO'S MET DOOR DE FABRIKANT VOORZIENE MONTAGEPUNTEN
 FELHELYEZÉS GYÁRTÓ ÁLTAL KIJELÖLT PONTRA
 SAMOCHODY Z PRZEWIDZIANYMI PUNKTAMI UMOCOWANIA
 MODELI Z PREDVIDENIM LE/ÆI©»EM S STRANI PROIZVAJALCA

MODELLI AUTO

PEUGEOT 206 3p.

7a

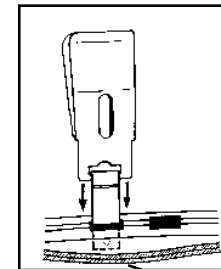
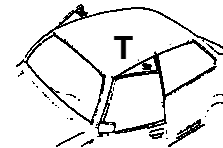
**ANTERIORE**

FRONT
 DELANTERO
 VORDERE
 AVANT
 VOORSTE G.
 ELSŐ RÚD
 PRZOD
 SPREDAJ

SCALZARE LA GUARNIZIONE

REMOVE THE GASKET
 QUITE LA MOLDURA
 DICHTUNG HERAUSZIEHEN
 OTER LA GUARNITURE
 PAKKUNG LOSMAKEN
 KIHAJTANI A TÖMITÖGUMIT
 WYCIAGNAC USZCZELKE
 ODMAKNITI TESNILO

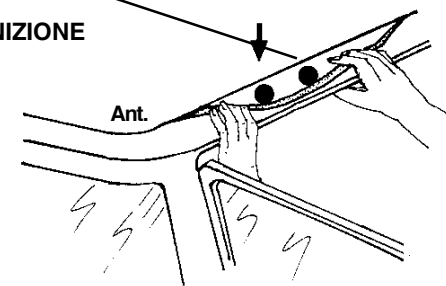

7b

**POSTERIORE**

REAR
 TRASERO
 HINTERE
 ARRIERE
 ACHTERSTE G.
 HÁTSÓ RÚD
 TYL
 ZADAJ

SCALZARE LA GUARNIZIONE

REMOVE THE GASKET
 QUITE LA MOLDURA
 DICHTUNG HERAUSZIEHEN
 OTER LA GUARNITURE
 PAKKUNG LOSMAKEN
 KIHAJTANI A TÖMITÖGUMIT
 WYCIAGNAC USZCZELKE
 ODMAKNITI TESNILO

