

8

**AVVITARE**

TO SCREW  
 APRETAR  
 FESTSCHRAUBEN  
 VISSER  
 VASTSCHROEVEN  
 MEGHÚZNI  
 WKRECIC  
 PRIVITI

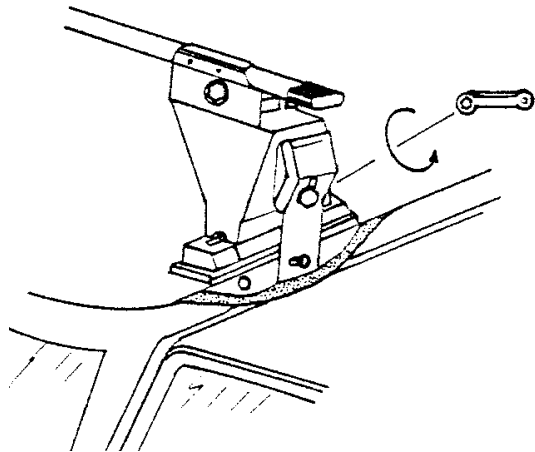

9

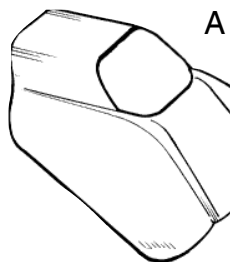
**OPTIONAL****INSERIRE**

INSERT  
 CUBRIR  
 STOPFEN  
 ENFILER  
 BEVESTIG  
 TOLJA FEL  
 NALOZIC  
 VSTAVITI

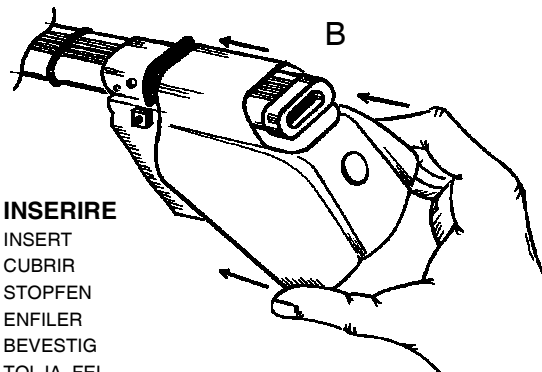

10

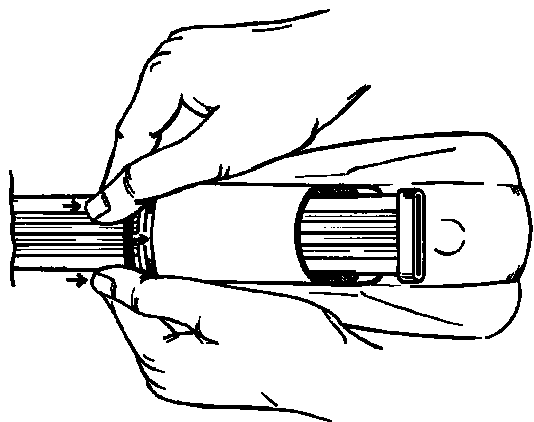
**31co**

ISTRUZIONI DI MONTAGGIO - FITTING INSTRUCTIONS - INSTRUCCIONES PARA SU MONTAJE -  
 MONTAGEANWEISUNGEN - INSTRUCTIONS DE MONTAGE - MONTAGE INSTRUCTIES -  
 SZERELÉSI UTASÍTÁS - INSTRUKCJA MONTAŻU - NAVODILA O MONTAŽI

**“LOGICO”**

1

**MISURE PRECISE**

EXACT DIMENSIONS  
 MEDIDAS CORRECTAS  
 GENAUUE MASSE  
 MESURES EXACTES  
 EXACTE AFMETINGEN  
 PONTOS MÉRET  
 DOKLADNE WYMIARY  
 TO»NE MERE

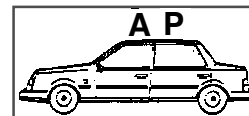
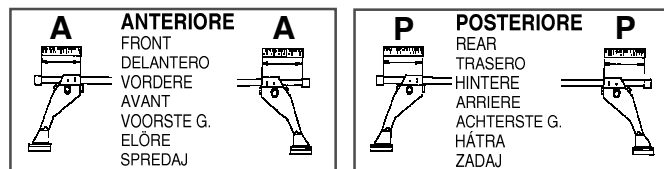
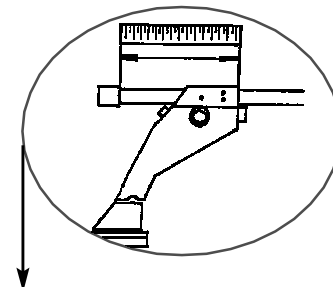

<b>A</b>	<b>P</b>
<b>ANTERIORE</b>	<b>POSTERIORE</b>
FRONT DELANTERO VORDERE AVANT VOORSTE G. ELSŐ RÚD PRZOD SPREDAJ	REAR TRASERO HINTERE ARRIERE ACHTERSTE G. HÁTSÓ RÚD TYL ZADAJ

LANCIA Y (95-&gt;03)

115 mm.

90 mm.

2

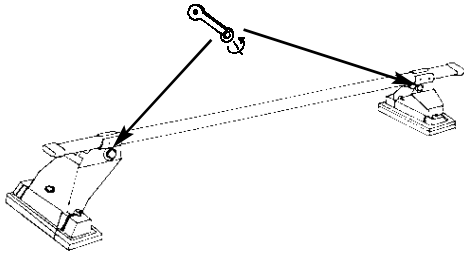
**AVVITARE (A FONDO)**

TO SCREW (DOWN)  
 APRETAR (A FONDO)  
 FESTSCHRAUBEN  
 VISSER (À FOND)  
 VASTSCHROEVEN  
 MEGHÚZNI  
 WKRECIC DO KONCA  
 PRIVITI (DO KONCA)

3

**TAGLIARE**

TO CUT  
 CORTAR  
 SCHNEIDEN  
 COUPER  
 SNIJDEN  
 ELVÁGNI  
 OBCIAC  
 ODREZATI

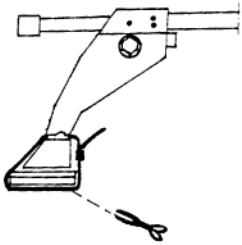

4

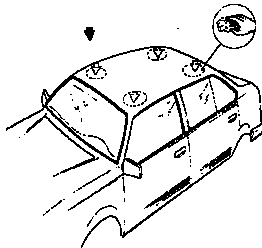
**PULIRE IL TETTO**

CLEAN THE ROOF  
 LIMPIAR EL TECHO  
 DACH REINIGEN  
 NETTOYER LE TOIT  
 DAK SCHOONMAKEN  
 TISZTÍTSA MEG A TETŐT  
 WYCZYSCIC DACH  
 O»ISTITI STREHO

5

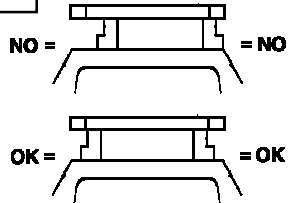
**CENTRARE IL P. TUTTO SUL TETTO**

CENTRE THE UNIVERSAL BAR  
 CARRIER ON THE ROOF  
 CENTRAR EL PORTAEQUIPAJES  
 SOBRE EL TECHO  
 LASTENTRÄGER AUF DEM DACH  
 ZENTRIEREN  
 CENTRER LE TOIT AVEC LE  
 PORTE-TOUIT  
 PLAATS DE UNIVERSELE DRAGER  
 IN HET MIDDEN VAN HET DAK  
 HELYEZZE KÖZÉPRE A RUDAKAT  
 WYSRODKOWAC BAGAŻNIK NA DACHU  
 CENTRIRATI PRTLJA»ENIK NA STREHO

6

**MODELLI AUTO**

CARS  
 COCHES  
 WAGEN  
 VOITURES  
 AUTO  
 AUTÓ TIPUS  
 MODELI AVTOMOBILOV

**MONTAGGIO GANASCINE**

HOW TO ASSEMBLE THE CLAMPS  
 COMO MONTAR LAS FIJACIONES  
 ZUSAMMENBAU DER  
 SPANNBACKEN  
 MONTAGE CROCHET  
 MONTAGE VAN DE KLEMMEN  
 RÖGZITŐ FÜLEK  
 MONTAZ SZCZEK MOCUJACYCH  
 MONTA»EA NAPENJALNIKA

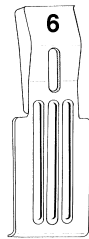
**LANCIA Y (95 ->03)****ANTERIORE**

FRONT  
 DELANTERO  
 VORDERE  
 AVANT  
 VOORSTE G.  
 ELSŐ RÚD  
 PRZOD  
 SPREDAJ

N°

3

**POSTERIORE**

REAR  
 TRASERO  
 HINTERE  
 ARRIERE  
 ACHTERSTE G.  
 HÁTSÓ RÚD  
 TYL  
 ZADAJ

N°

6

7

**MODELLI CON PREDISPOSIZIONE DELLA CASA AUTO:**

CARS WITH PRE-EXISTING FIXING POINT FROM MANUFACTURER  
 MODELOS CON PREDISPOSICION DEL FABRICANTE  
 AUTOS MIT VOM HERSTELLER VORGESEHENE BEFESTIGUNGSPUNKTE  
 VOITURES AVEC POINTS DE FIXAGE PREVUS PAR LE CONSTRUCTEUR  
 AUTO'S MET DOOR DE FABRIKANT VOORZIENE MONTAGEPUNTEN  
 FELHELYEZÉS GYÁRTÓ ÁLTAL KIJELÖLT PONTRA  
 SAMOCHODY Z PRZEWIDZIANYMI PUNKTAMI UMOCOWANIA  
 MODELI Z PREDVIDENIM LE»EM S STRANI PROIZVAJALCA

**MODELLI AUTO****LANCIA Y (95 ->03)**

7a

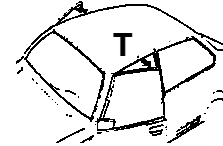
**SCALZARE LA GUARNIZIONE**

REMOVE THE GASKET  
 QUITE LA MOLDURA  
 DICHTUNG HERAUSZIEHEN  
 OTER LA GUARNITURE  
 PAKKUNG LOSMAKEN  
 KIHAJTANI A TÖMITÖGUMIT  
 WYCIAGNAC USZCZELKE  
 ODMAKNITI TESNILO

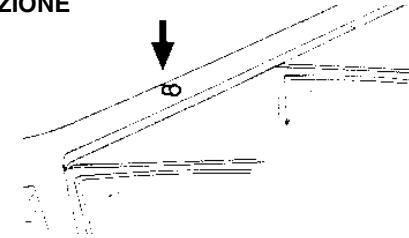
**ANTERIORE**

FRONT  
 DELANTERO  
 VORDERE  
 AVANT  
 VOORSTE G.  
 ELSŐ RÚD  
 PRZOD  
 SPREDAJ

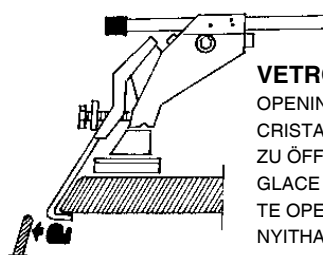
**VETRO APRIBILE**

OPENING WINDOW  
 CRISTAL ABATIBILE  
 ZU ÖFFNENENDE GLASSCHEIBE  
 GLACE OUVRABLE  
 TE OPENEN RUIT  
 NYITHATÓ ÜVEGEZÉS  
 SZYBA OTWIERAJACA SIE  
 OKNO Z MO»ENOSTJO ODPIRANJA

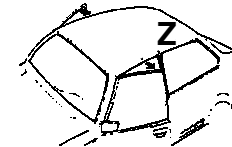
**POSTERIORE**

REAR  
 TRASERO  
 HINTERE  
 ARRIERE  
 ACHTERSTE G.  
 HÁTSÓ RÚD  
 TYL  
 ZADAJ

7b

**SCALZARE LA GUARNIZIONE**

REMOVE THE GASKET  
 QUITE LA MOLDURA  
 DICHTUNG HERAUSZIEHEN  
 OTER LA GUARNITURE  
 PAKKUNG LOSMAKEN  
 KIHAJTANI A TÖMITÖGUMIT  
 WYCIAGNAC USZCZELKE  
 ODMAKNITI TESNILO

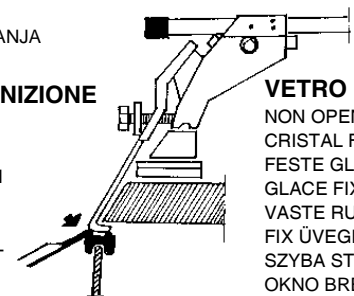
**VETRO FISSO**

NON OPENING WINDOW  
 CRISTAL FIJO  
 FESTE GLASSCHEIBE  
 GLACE FIXE  
 VASTE RUIT  
 FIX ÜVEGEZÉS  
 SZYBA STALA  
 OKNO BREZ MO»ENOSTI  
 ODPIRANJA